

VIZIO

UNIVERSAL WIRELESS
HD VIDEO & AUDIO KIT

XWH200 – QUICK START GUIDE

PACKAGE CONTENTS



Transmitter



Receiver



Remote Control



Wall Mounting Template



Quick Start Guide



Power Adapter (2)



HDMI Cable (2)

WELCOME!

Thank you for choosing the VIZIO Universal Wireless HD Video & Audio Kit.

Using this kit, you can wirelessly connect your HDMI devices to your TV from anywhere in the room, keeping your entertainment area looking clean. You no longer need to hide cabling behind walls or ceilings!

Before you begin the first-time setup:

- Turn your TV and all HDMI devices **off**.
- Position your HDMI devices in the **same room** as the TV (up to 30 feet away).
- Ensure you have one HDMI cable for each device you want to connect.
- Ensure there are available electrical outlets near your devices and your TV.
- Read the important safety instructions on page 14.

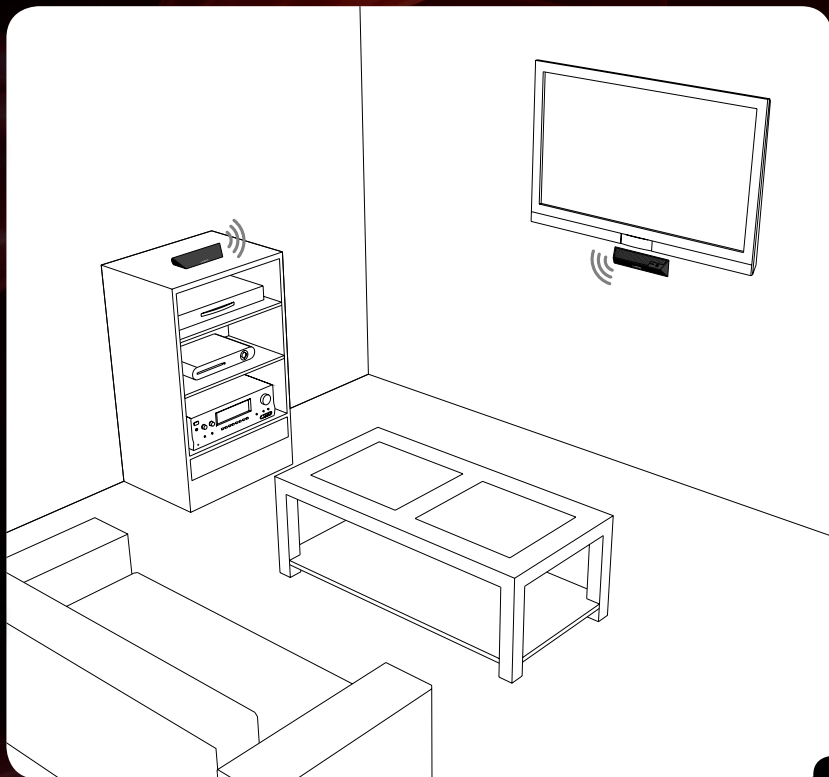

1

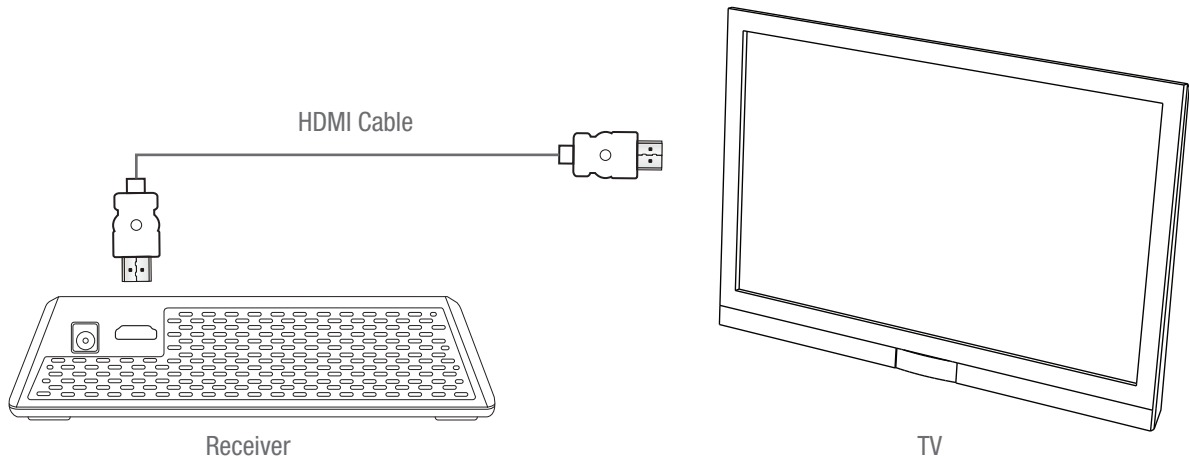

Connect your TV to the receiver using an HDMI cable.
For wall mounting instructions, see *Wall Mounting the Receiver* on page 9.

2

Receiver

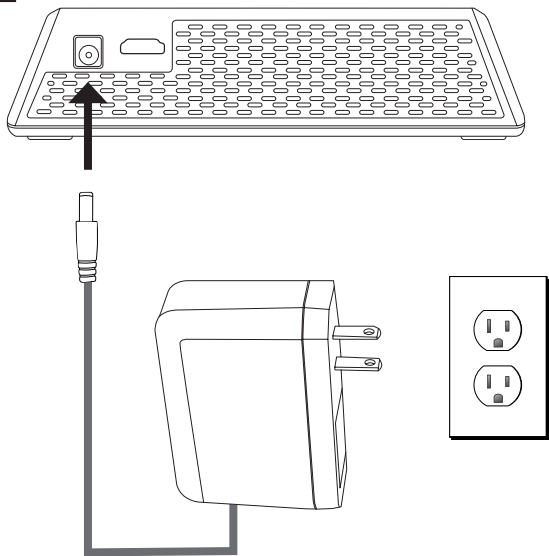

Connect a power adapter to the receiver as shown.
Connect the power adapter to an electrical outlet.

3

Remote Control

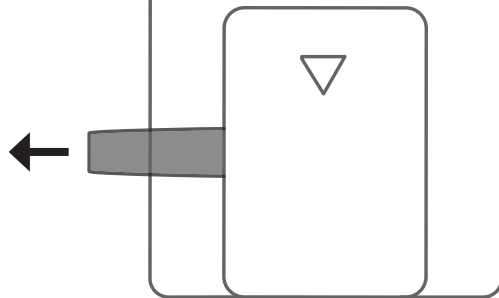

Pull the plastic tab from the battery compartment
on the remote control.

4

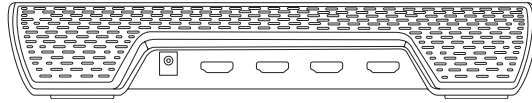

Transmitter

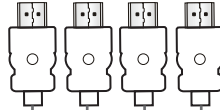

HDMI Cables

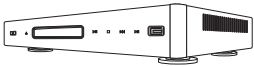
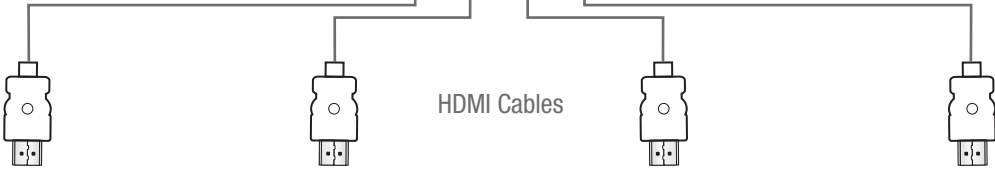

DVD/Blu-ray™ Player

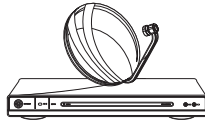

Cable/Satellite Box

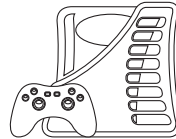

Game Console

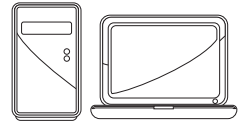

Computer

Connect up to 4 HDMI devices to the transmitter using HDMI cables.
(Devices shown are examples. Any HDMI devices can be connected.)

5

Transmitter

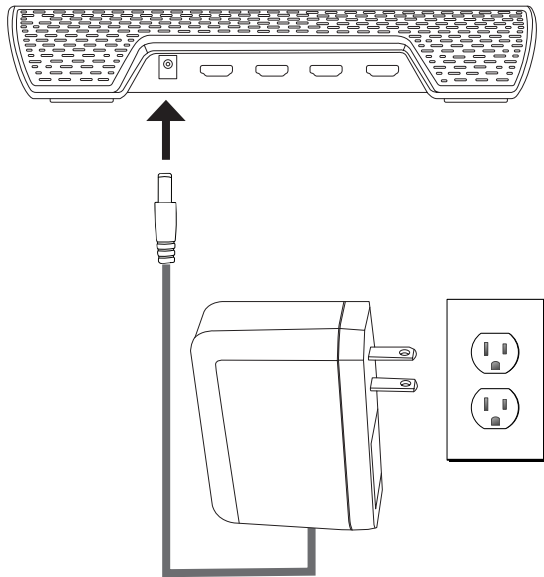

Connect a power adapter to the transmitter as shown.
Connect the power adapter to an electrical outlet.

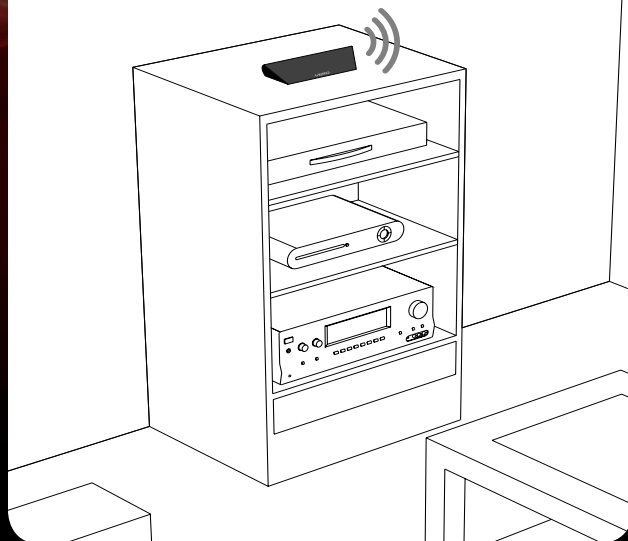
6

Place the transmitter in a location where it is free from
obstructions. Face it toward the receiver.

7

Receiver

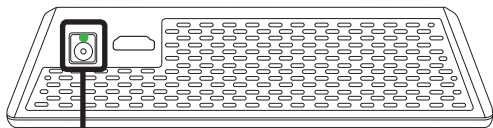

Wait for light to stop blinking.
This may take up to 30 seconds.

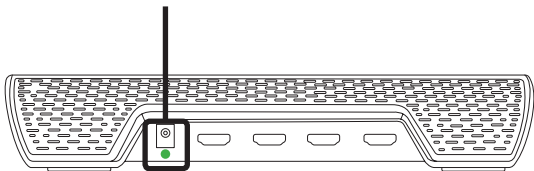

Transmitter

Check the transmitter and receiver power lights. If the lights are blinking, move the **transmitter** for a better signal.

8

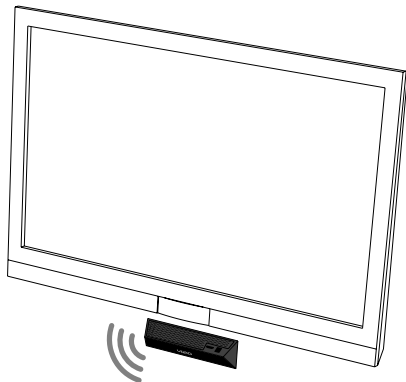

Turn on your TV and change the display input to the receiver's port (HDMI-1 or HDMI-2, etc).

9

Input Selector

Press the number that matches the transmitter HDMI input you wish to view. (Press **1** to view the **HDMI 1** device, etc.)

OR

Input

Touch repeatedly to cycle through available devices.

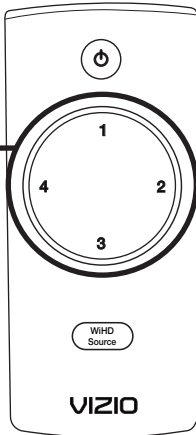
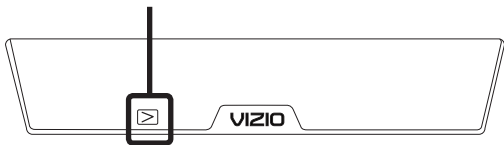

10

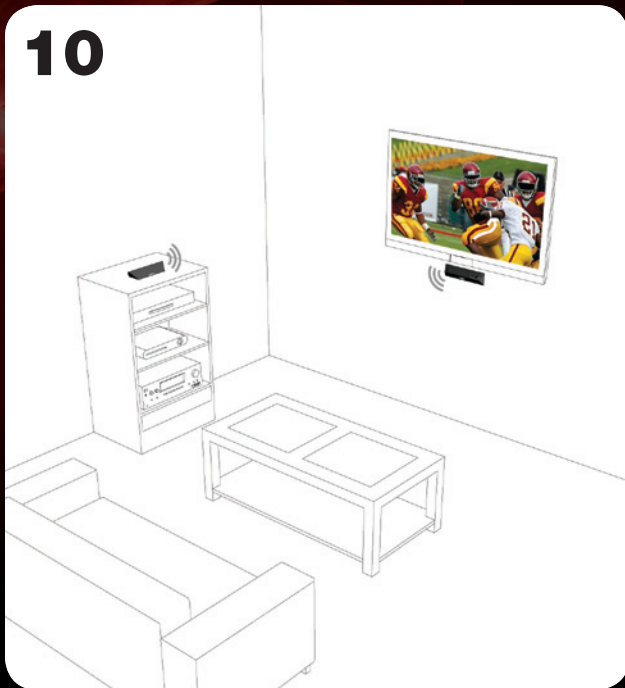

Use the **INPUT SELECTOR** button on the remote or the **INPUT** touch control on the transmitter to display your device.

Your TV displays the output from the selected device.

WALL MOUNTING THE RECEIVER

1

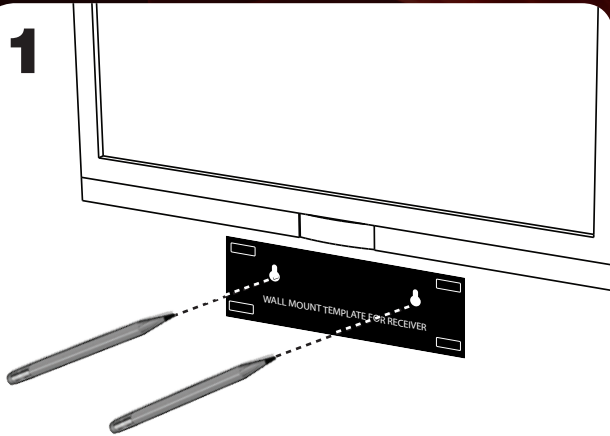

Place the included wall template on the wall where you want to hang the receiver, then mark the points where screws must be fixed. (Screws not included.)

2

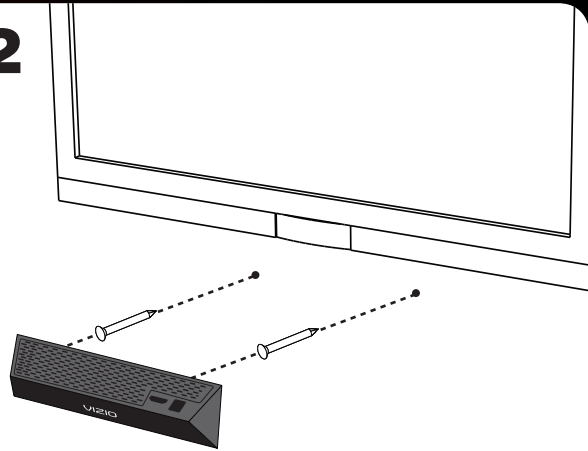

Fix the screws to the wall, then hang the receiver.

USING THE REMOTE



Point Remote at Receiver

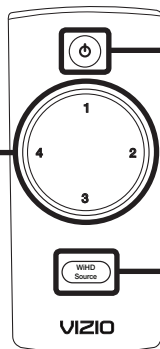

Input Selector

Press the number that matches the transmitter HDMI input you wish to view. (Press **1** to view the **HDMI 1** device, etc.)

Power/Standby

Press to put transmitter and receiver in or out of standby mode.

WiHD Source

Press to display output from a 2nd WiHD transmitter. This button is only used when 2 transmitters are used together.

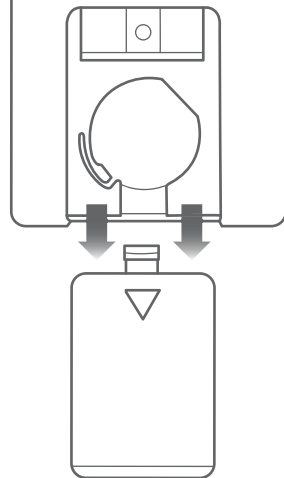

To replace the battery, gently press down on the battery cover and slide it away from the remote.

Insert a new CR2032 battery.

Slide the battery cover until it snaps back into place.

TROUBLESHOOTING, FAQ, & TECHNICAL SUPPORT

Products are often returned due to a technical problem rather than a defective product. Our trained support personnel can often resolve the problem over the phone. For more information on service or repair after the warranty period, please contact our Support Department.

Phone: (877) 698-4946
Fax: (949) 585-9563
Email: techsupport@vizio.com
Web: www.VIZIO.com

Customer support and quality service are integral parts of VIZIO's commitment to service excellence. For technical assistance contact our VIZIO Technical Support Department via email or phone. Please have your VIZIO model number, serial number, and date of purchase available before your call.

Hours of operation:

Monday - Friday: 6 am to 9 pm (PST)
Saturday - Sunday: 8 am to 4pm (PST)

The receiver is not responding to the transmitter.

- Ensure your TV is set to display the HDMI input to which the receiver is connected.
- Ensure the transmitter is set to the proper HDMI port. The light below the active port will be on.
- Try to reposition the transmitter. Place it in an area free from obstructions, facing the receiver. You may need to place the transmitter closer to the receiver.
- Unplug the transmitter and receiver from the electrical outlet. Plug them back in.
- Press and hold the **INPUT** button on the front of the transmitter for 5 seconds. Wait until the power lights on the transmitter and receiver stop blinking. This may take up to 30 seconds.
- Ensure your TV and HDMI devices are using the latest firmware from the manufacturer's website.

Can I use more than one transmitter if I have 5 or more HDMI devices?

- Yes. Connect a second transmitter in the same way as the first. Press and hold the **INPUT** button on the front of the new transmitter for 5 seconds. When the light next to the power port is solid (not blinking), the new transmitter is linked to the receiver. Use the **WiHD Source** button on the remote to switch the input source from one transmitter to another.

What do the lights below the HDMI ports on the transmitter mean?

- If the light is **solid** (not blinking), the HDMI connection is good and the input is set to that port.
- If the light is **blinking**, check the cable for a secure connection. Ensure your device is on and is playing content. Ensure your device is set to output to its HDMI port.

The light next to the power port is blinking.

- The transmitter and receiver may not be positioned for the best connection. Move the transmitter to a new location. Ensure the transmitter and receiver are in areas free from obstructions. Do not place the transmitter or receiver inside enclosures built from metal or other dense materials.
- When the light is solidly lit (stops blinking), the transmitter and receiver are linked.

Are 3D movies and 3D gaming supported?

- Yes, 3D is supported on 3D-capable TVs and devices. See your device's user manual for details.

I am having trouble changing inputs.

- Be sure to point the remote directly at the receiver when pressing the **INPUT SELECTOR** buttons. When you press the buttons, the light below the selected HDMI port should turn on. If the remote does not work, touch the **INPUT** control on the front of the receiver. Do not wear gloves when using this control.
- You may need to replace the battery in the remote. See *Using the Remote* on page 10.

There is a delay when I change inputs (1, 2, 3, 4).

- This is normal. When changing the input, you may experience a delay of up to 20 seconds before the picture is displayed on your TV.

ONE-YEAR LIMITED WARRANTY

ON PARTS AND LABOR

Covers units purchased as new in United States and Puerto Rico Only

VIZIO provides a warranty to the original purchaser of a new Product against defects in materials and workmanship for a period of one year of non-commercial usage and ninety (90) days of commercial use. If a Product covered by this warranty is determined to be defective within the warranty period, VIZIO will either repair or replace the Product at its sole option and discretion. To obtain warranty service, contact VIZIO Technical Support via email: TechSupport@VIZIO.com or via phone at 877 MY VIZIO (877.698.4946) from 6:00AM to 9:00PM Monday through Friday and 8:00AM to 4:00PM Saturday and Sunday, Pacific Time, or visit www.VIZIO.com. PRE-AUTHORIZATION MUST BE OBTAINED BEFORE SENDING ANY PRODUCT TO A VIZIO SERVICE CENTER. Proof of purchase in the form of a purchase receipt or copy thereof is required to show that a Product is within the warranty period.

Parts and Labor

There will be no charge for parts or labor during the warranty period. Replacement parts and Products may be new or recertified at VIZIO's option and sole discretion. Replacement parts and Products are warranted for the remaining portion of the original warranty or for ninety (90) days from warranty service or replacement, whichever is greater.

Type of Service

Defective Products must be sent to a VIZIO service center to obtain warranty service. VIZIO is not responsible for transportation costs to the service center, but VIZIO will cover return shipping to the customer. PRE-AUTHORIZATION IS REQUIRED BEFORE SENDING ANY PRODUCT TO A VIZIO SERVICE CENTER FOR WARRANTY SERVICE. Product returns to VIZIO's service centers must utilize either the original carton box and shipping material or packaging that affords an equal degree of protection. VIZIO Technical Support will provide instructions for packing and shipping the covered Product to the VIZIO service center.

Limitations and Exclusions

VIZIO's one-year limited warranty only covers defects in materials and workmanship. This warranty does not cover, for example: cosmetic damage, normal wear and tear, improper operation, improper voltage supply or power surges, signal issues, damages from shipping, acts of God, any type of customer misuse, modifications or adjustments, as well as installation and set-up issues or any repairs attempted by anyone other than by a VIZIO authorized service center. Products with unreadable or removed serial numbers, or requiring routine maintenance are not covered. This one year limited warranty does not cover Products sold "AS IS", "FACTORY RECERTIFIED", or by a non-authorized reseller.

THERE ARE NO EXPRESS WARRANTIES OTHER THAN THOSE LISTED OR DESCRIBED ABOVE. ANY IMPLIED WARRANTIES, INCLUDING ANY IMPLIED WARRANTY OF MERCHANTABILITY AND FITNESS FOR A PARTICULAR PURPOSE, SHALL BE LIMITED IN DURATION TO THE PERIOD OF TIME SET FORTH ABOVE. VIZIO'S TOTAL LIABILITY FOR ANY AND ALL LOSSES AND DAMAGES RESULTING FROM ANY CAUSE WHATSOEVER INCLUDING VIZIO'S NEGLIGENCE, ALLEGED DAMAGE, OR DEFECTIVE GOODS, WHETHER SUCH DEFECTS ARE DISCOVERABLE OR LATENT, SHALL IN NO EVENT EXCEED THE PURCHASE PRICE OF THE PRODUCT. VIZIO SHALL NOT BE RESPONSIBLE FOR LOSS OF USE, LOSS OF INFORMATION OR DATA, COMMERCIAL LOSS, LOST REVENUE OR LOST PROFITS, OR OTHER INCIDENTAL OR CONSEQUENTIAL DAMAGES. SOME STATES DO NOT ALLOW LIMITATIONS ON HOW LONG AN IMPLIED WARRANTY LASTS OR THE EXCLUSION OF INCIDENTAL OR CONSEQUENTIAL DAMAGES, SO THE ABOVE LIMITATIONS OR EXCLUSIONS MAY NOT APPLY TO YOU. THIS WARRANTY GIVES YOU SPECIFIC LEGAL RIGHTS, AND YOU MAY ALSO HAVE OTHER RIGHTS, WHICH VARY FROM STATE TO STATE. THIS WARRANTY IS SUBJECT TO CHANGE WITHOUT NOTICE.

CHECK www.VIZIO.com FOR THE MOST CURRENT VERSION.

SPECIFICATIONS

RF Frequency: 60 GHz

Bandwidth: HRP - 1.76 GHz
LRP - 92 MHz

Max Throughput: 4 Gbps

Range: Up to 65 feet (Line of Sight)
Up to 30 feet (Non-Line of Sight)

Supported 2D Resolutions: 480i, 480p, 720p, 1080i, 1080p, VGA, XGA, SXGA, WSXGA+

Supported 2D Refresh Rates: 23.976/24 Hz, 59.94/60 Hz

3D Video Mode Compatibility: 720p 50/59.94 Hz, 1080p 23.98/24 Hz, Sensio, RealD

Audio Mode Support: 2-8ch LPCM, 32-192 KHz, Dolby Digital 5.1 @ 44.1 / 48 / 96 KHz, DTS 5.1 @ 44.1 / 48 / 96 KHz

HDMI Support: HDMI 1.4a (3D) with CEC

LEGAL NOTICES

FCC Class B Radio Interference Statement

This equipment has been tested and found to comply with the limits for a Class B digital device, pursuant to Part 15 of the FCC Rules. These limits are designed to provide reasonable protection against harmful interference in a residential installation. This equipment generates, uses and can radiate radio frequency energy, and if not installed and used in accordance with the instructions, may cause harmful interference to radio communications. However, there is no guarantee that interference will not occur in a particular installation. If this equipment does cause harmful interference to radio or television reception, which can be determined by turning the equipment off and on, the user is encouraged to try to correct the interference by one or more of the following measures:

1. Reorient or relocate the receiving antenna.
2. Increase the separation between the equipment and receiver.
3. Connect the equipment into an outlet on a circuit different from that to which the receiver is connected.
4. Consult the dealer or an experienced radio/TV technician for help.

This device complies with Part 15 of the FCC Rules. Operation is subject to the following two conditions: (1) this device may not cause harmful interference, and (2) this device must accept any interference received, including interference that may cause undesired operation.

Notice

1. Any changes or modifications not expressly approved by the party responsible for compliance could void the user's authority to operate the equipment.
2. Shielded interface cables and AC power cord, if any, must be used in order to comply with the emission limits.

IMPORTANT SAFETY INSTRUCTIONS

- Heed all warnings.
- Follow all instructions.
- Clean only with a dry cloth.
- Do not block any ventilation openings. Install in accordance with the accompanying instructions and/or wall mounting template. Only use accessories specified by VIZIO.
- Do not install near any heat sources such as radiators, heat registers, stoves, or other heat generating devices (including amplifiers).
- To reduce the risk of fire or electric shock, do not use near water or expose to rain or moisture. Your device should not be exposed to dripping or splashing.

3. The manufacturer is not responsible for any radio or TV interference caused by unauthorized modification to this equipment. It is the responsibility of the user to correct such interference.

FCC Radiation Exposure Statement

This equipment complies with FCC radiation exposure limits set forth for an uncontrolled environment. This equipment should be installed and operated with minimum distance 20cm between the radiator & your body.

IC Statement

Operation is subject to the following two conditions: (1) this device may not cause interference, and (2) this device must accept any interference, including interference that may cause undesired operation of the device.

IC Radiation Exposure Statement

This equipment complies with IC RSS-102 radiation exposure limits set forth for an uncontrolled environment. This equipment should be installed and operated with minimum distance 20cm between the radiator & your body.



HDMI, the HDMI logo and High-Definition Multimedia Interface are trademarks or registered trademarks of HDMI Licensing LLC.



WiHD and WiHD logo are trademarks licensed for use by WirelessHD, LLC.

- Protect the power cord from being walked on or pinched, particularly at plugs, and where they exit from your player.
- Unplug your device during lightning storms or when unused for long periods.
- Refer all servicing to qualified service personnel. Servicing is required when your device has been damaged in any way, such as when the power supply cord or plug is damaged, when liquid has been spilled or objects have fallen into your device, when your device has been exposed to rain or moisture, or when your device does not operate normally or has been dropped.
- Do not place items with flames, such as candles, on or near your device.
- Dispose of batteries according to local hazardous waste regulations.



TRADEMARKS SHOWN ARE THE PROPERTY OF THEIR RESPECTIVE OWNERS. IMAGES USED ARE FOR ILLUSTRATION PURPOSES ONLY. VIZIO, THE V LOGO, WHERE VISION MEETS VALUE, AND OTHER VIZIO TRADEMARKS ARE THE INTELLECTUAL PROPERTY OF VIZIO INC. PRODUCT FEATURES AND SPECIFICATIONS ARE SUBJECT TO CHANGE WITHOUT NOTICE.
© 2010 VIZIO INC. ALL RIGHTS RESERVED.

101207ST-NC